



User Manual

Hydro Charger Deluxe

1. Content
2. Tools / Material
3. Mounting on transom
4. Mounting Hydro Charger Deluxe
5. Mounting Charge Controller
6. Programming Charge Controller
7. Trouble Shooting
8. Alerts
9. Maintenance
10. Technical Specifications / Supports
11. Warranty
12. Mounting diagram bracket for transom / propeller



1. Content

Art. No. 7137/7138 Transom Hydro Charger Deluxe 12/24 V completely ready for installation

- Generator with shaft and lifting mechanism with 3 lines, 4 m 3-core cable tin plated, 2,5 mm²
- Propeller complete with propeller blades preset in according to order, 1 pin, a big and a small U-disc and M10 stop nut
- Charge Controller 12/24 volt, with LED/alarm buzzer and 4m cable
- Waterproof, complete connector kit
- Transom bracket with counterplate and screws Art. 7220*
- (*as standard we deliver the normal bracket (Art. 7220), if a different support is ordered. We will just deliver the needed parts and the other support will be charged separately)
- User manual attached (separately)
- User manual Charge Controller attached
- 4 (pre assembled) and 10 Crash-Secure plastic screws on reserve

2. Tools/ Materials

- 17 mm socket wrench for propeller
- 13 mm wrench for pipe clamps for installation of transom bracket with counterplate
- 6mm Allen key for propeller cap
- Little Screw driver for installation of plug
- Batterie cable min. 6 mm², length depending of installation (Controller to batteries)
- Cable ties
- Waterproof connector
- Pincer

3. Mounting on transom

The Hydro Charger Deluxe propeller should be at least 30 cm under water thus applied a uniform flow. The position of the heel should always be as close as possible near the centerline of the boat on the transom, but laterally (10-20cm) offset from rudders and boat propeller.

Please make sure that the transom mount is internally well supported to the counter-plate. In a very thin transom wall, it's recommended to reinforce the wall still further. Please have a look on the separate manual at the end.

Propeller assembly: the large, 30 mm special disc is pushed onto the propeller shaft, then the small pin of the propeller is inserted into the corresponding whole, so that it protrudes equally far on both sides. When you put on the propeller on the shaft, the pin must fit in the slot of the propeller.

Important: the pin must fit in the slot of the propeller exactly, otherwise the propeller can be lost during the trip !!! (we recommend mark with a marker outside of the propeller so that the position can be determined better)

With washer and self-locking nut, the propeller will be screwed with a 17-socket key (tightly!) Then attach the end cap with the 3 screws. (see sketch at the end of the manual)

Due to possible transport damage, we always deliver the propeller well packed separately.

4. Mounting Hydro Charger Deluxe

The appropriate transom bracket should be mounted.

Subsequently, the base support and the generator can be plugged together with the thick washer below (1), screw and tighten security nut fastened (2). Then the generator will be mounted to the base support of the respective bracket and secured with the safety pin. Connect the pulley (3) in one whole of the frame. (on each side there is a whole, so you can choose the best position on your boat when you lift up the charger)

The Hydro Charger Deluxe always should be ADDITIONELLY SECURED to the boat. These ropes serve for raising and lowering of the generator.

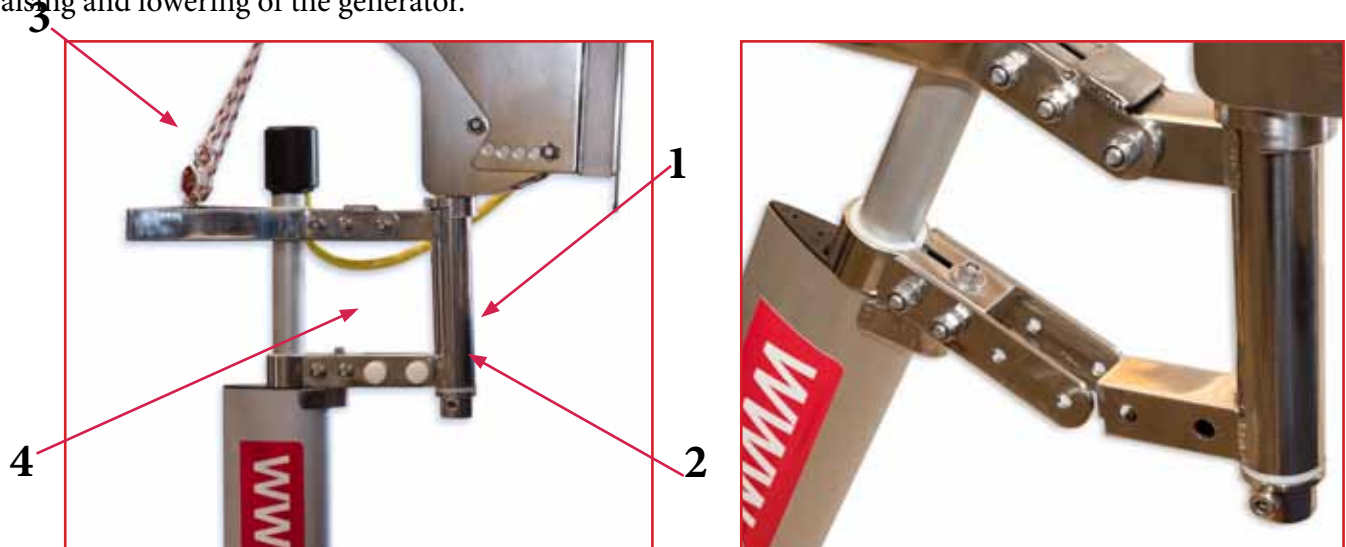

At the lower segment the inclination of the transom can be compensated so that the Hydro Charger Deluxe can operate in the water in vertical position. The propeller center should be at least 30 cm under the water.

For the crash protection, we recommend initially mounting 1 plastic screw (4) and increasing it as required (depending on the type of vessel and the speed of the ship). The breaking load per screw corresponds to approx. 30 kg.

In the event of a collision, the screw shears off and the Hydro Charger Deluxe folds back so that no damage occurs. After installing a new plastic screw you can use the Hydro Charger Deluxe as usual.

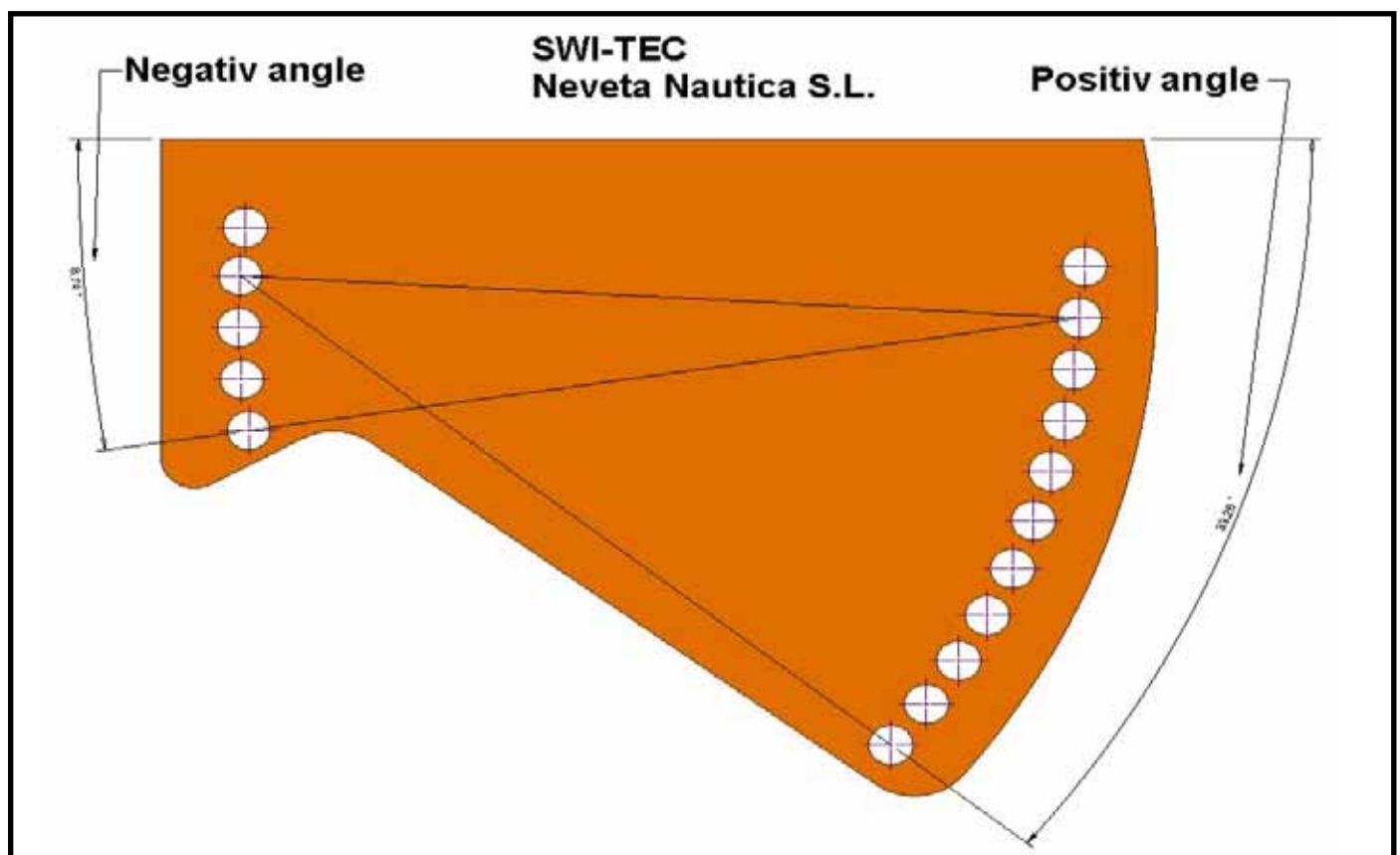

5. Installation of the charge controller

If you would like to connect the HydroCharger with Lithium batteries, you should obtain the autorisation of the battery manufacturer. In any case you have to connect a relay between the Hydro Charger and the controller, which is controlled through the electronic management of the Lithium battery. In case of problems with the Lithium batteries, we don't accept any form of warranty!

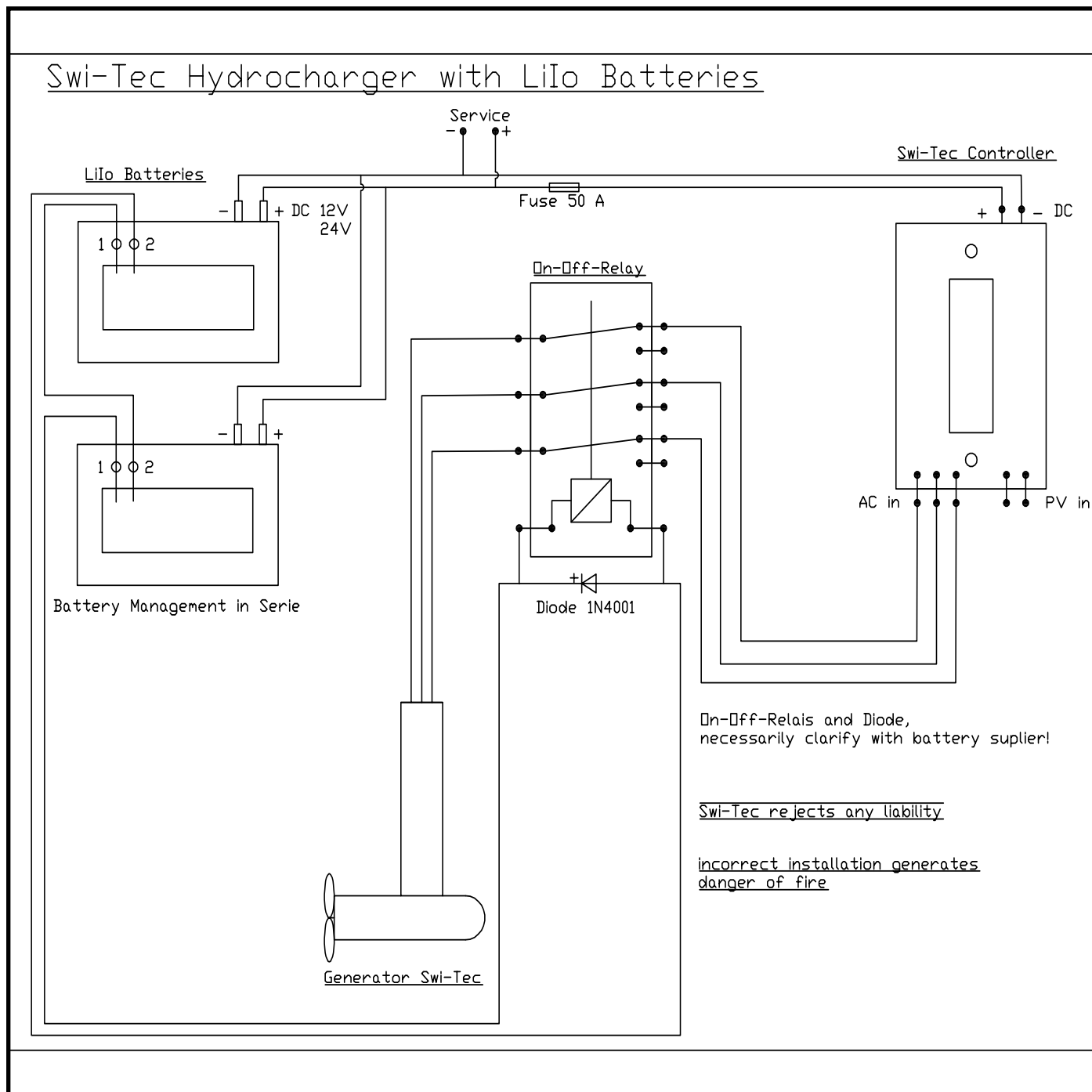

The charge controller will be placed and fixed with four screws in a dry compartment in the vicinity of the batteries in a manner that you can see good the digital display. The battery cables should be as short as possible.

Plus on the connector "Batt +" and with a red cable on the plus of the battery and the black cable from the "Batt -". A 40 Amp fuse in the red wire protects the Hydro Charger Deluxe in case of a short circuit of the batteries.

From the three screw connectors "Generator" of the controller a 3-core cable should be installed, according to the length of the boat. For the connection on the transom a waterproof connector should be installed together with the yellow cable coming from the generator. As this cable is carrying alternative current the phase sequence doesn't matter.

Solar panels of 400 watts can be installed on the boat. They can be connected to the screw connector "Solar +" and "Solar -".

The connection „remote brake“ is the port for the alarm buzzer.

It is important that during the connection of the charge controller, first, the battery is connected to the device, and afterwards the other components. The battery shouldn't be discharged too low, because the electronics have to turn on the unit and also the correct voltage must recognize 12/24 V.

Attention: in case of reverse polarity + and -, the controller will eventually be destroyed.

Generator never in use with batteries disconnected. Controller could be destroyed!!!

6. Programming of charge controller

This controller is preprogrammed, you can adjust the parameters before use.

The controller contains the terminals for generator, batteries and for consumers, informative LED display, the red free-wheel switch and the black brake switch.

Acid batteries release gases during operation, the controller should not be installed in the field of batteries, due to explosion risk.

The remote control unit has five buttons, scrolling through service, by pressing "Menu" and with „OK“ the other way around.. With + and - you can adjust the various parameters. With the "Reset" button, the settings will be reset.

The separate manual Hydro & Solar Hybrid Charge Controller explains the functioning and operation of the charge controller.

You can connect consumers on the connection "load" to the control unit. Here, the shutdown can be predefined. In addition you can check the amperes on the display.

With the red free-wheel switch with the battery voltage on the maximum, you can leave the propeller in free.

The control unit is connected and programmed, the boat outside of the port and under sails, the Hydro Charger Deluxe can be lowered now into the water.

From now on, the charge details on the digital display are monitored at all the time. If full charge is reached and no consumer is connected directly, you receive a signal from the alarm buzzer, it is recommended to switch on the free-wheel and /or take the Hydro Charger Deluxe out of the water, to reduce drag and wear.

Important: If you start with full charged batteries, the Hydro Charger Deluxe will only produce less or no electricity!

Also if the switch „Free on“ is connected there will no charging.

7. Troubleshooting

The propeller does not begin to spin:

- To little speed, at least 3 to 4 knots are necessary (depending of propeller pitch adjusted)
- The cables are connected incorrectly causing a short circuit
- The propeller is bent
- No battery connected to the controller
- The controller or generator is defective
- The black brake switch is on, put off

If the generator shows to small power:

- Speed too low
- Propeller dirty
- Position not good or generator too short in the water
- The cable section does not fit to the installed length
- The installed battery capacity is too small, so the final voltage is reached too early (battery should have at least 200Ah)
- The red free-wheel switch is on, put on off

The generator is vibrating:

- Propeller dirty
- Propeller bent
- The switch „brake“ is on, switch it off

Before the manufacturer is contacted, measure the following parameters and share with the manufacturer:

1. Speed of vessel?
2. How deep is the propeller shaft in the water?
3. The propeller is in vertical position when it is under water?
4. Disconnect the three cables on the generator and spin the propeller by hand fast and measure between the 2 pin rotate the AC voltage between the phases. You must measure 3 or more volts
5. Measure the battery voltage
6. What consumers running on the battery?
7. In case of connected solar panels and /or wind generator, check voltage (volt) and power (watt).

8. Safety

Warnings:

The generator should be placed in the water with no possibilities to touch them while working.

Never stop the propeller by hand.

The Hydro Charger Deluxe is no bath ladder.

Replace fuses only with fuses of the original capacity. Before the fuse is replaced, the causing problem should be known.

Lift the Hydro Charger Deluxe always out of the water, when work is performed on it.

The charger controller can become hot. Ensure good ventilation.

Never operate the generator disconnected to the batteries (2 cables + and -)! The controller will be destroyed!

9. Maintenance / Storage

So that you long enjoy the Hydro Charger Deluxe, you should check periodically.

The first inspection on the first day, then at longer intervals.

The following points should be considered:

- Attention to vibrations

- Foot should be always in vertical position while working
- The propeller spins easily
- Damage on the propeller blades
- All screws are firmly tight on the Hydro Charger Deluxe
- Are all cables and connections in order and not corroded
- Is no wear on the cables
- If the safety line is still in perfect conditions

The unit requires no special maintenance, except for regular cleaning with fresh water. Then let it dry and spray with preservative oil.

If you store the Hydro Charger Deluxe for a longer time, we recommend to store it in vertical position, because it is filled for cooling with special oil and this can leak a little on a long time storage in horizontal position.

10. Technical Specification

Art. No. 7137/7138

Generator with Converter Charger, basic and mounting bracket

| | |
|--|---|
| Generator part: | Gear drive with shaft, propeller and programmable converter charger with remote digital display and 4 m 3- core cable |
| Performance: | generates power from around 4 knots depending of propeller pitch, regulated in the factory |
| Output: | 50-500Watts depending on speed and battery load |
| Weight: | complete generator, propeller und basis bracket in stainless steel (316), approx. 18 kg |
| Dimensions: | See last page in this manual Propeller diameters: 380 mm |
| Converter Charger: | Performance: 1000W (max. Hydro Charger Deluxe 600W, Solar panel 400W) |
| Batteries: | 12 Volt / 24 Volt, 200Ah or more / 100Ah or more (Voltage detected automatically) |
| Max. batt. Voltage charge stop: | 16V/32V (adjustable) |
| Min. batt. Voltage for charge stop: | 11V/22V (adjustable) |
| Max. Charge current: | 40A (20A by 24V) |
| Max. Load current: | 15A (7,5A by 24V) |
| Recovery time after autom. free-wheel: | 60 Seconds |
| No load loss: | smaller 45mA |
| Dimensions controller: | 278 x 133 x 75 mm |
| Weight: | 1,6 kg |
| Working environment: | -10 to +50 Degree Celsius, rel. humidity 0-90% |

Art. No. 7220

Extra bracket for transom

If you want to use the Hydro Charger Deluxe on both sides

Art. No. 7210

Angle mount bracket for transom

This bracket is for platforms and Catamaran

Art.No. 7149

Pivotable bracket for transom mounting (new!)

The advantage of this bracket is that the Hydro Charger Deluxe is always in vertical position.

11. Warranty

SWI-TEC, Neveta Nautica S.L. guarantee, that this unit during 24 months, from the date of purchasing from SWI-TEC, has no material and production defects, which do not allow the perfect function of the Hydro Charger Deluxe. In case of defects during this period, immediate communication to **SWI-TEC, Neveta Nautica S.L.** is recommended.

Shipping cost back to the factory and back to customer is not included in warranty!

SWI-TEC will check the warranty claim and will repair the unit, depending of the damage, only parts or the whole Hydro Charger Deluxe. The place of guarantee is the production place in E-07680 Porto Cristo (Mallorca).

Assumption of guarantee is that the Hydro Charger Deluxe has suffered no unprofessional actions and the recommendations of the owner's manual are fully maintained during the use of the unit.

Damages through force majeure, as storms, as wars, etc. are not included in this warranty.

For all other cases the terms of business from **SWI-TEC, Neveta Nautica S.L.** are valid.

We wish you a lot of pleasure with the Hydro Charger Deluxe.

SWI-TEC, Neveta Nautica S.L.

Poligono 9, Apt. 51

E-07680 Porto Cristo (Mallorca)

Tel. +34 971 822426, Fax: +34 971 822017

E-Mail: info@swi-tec.com www.swi-tec.com

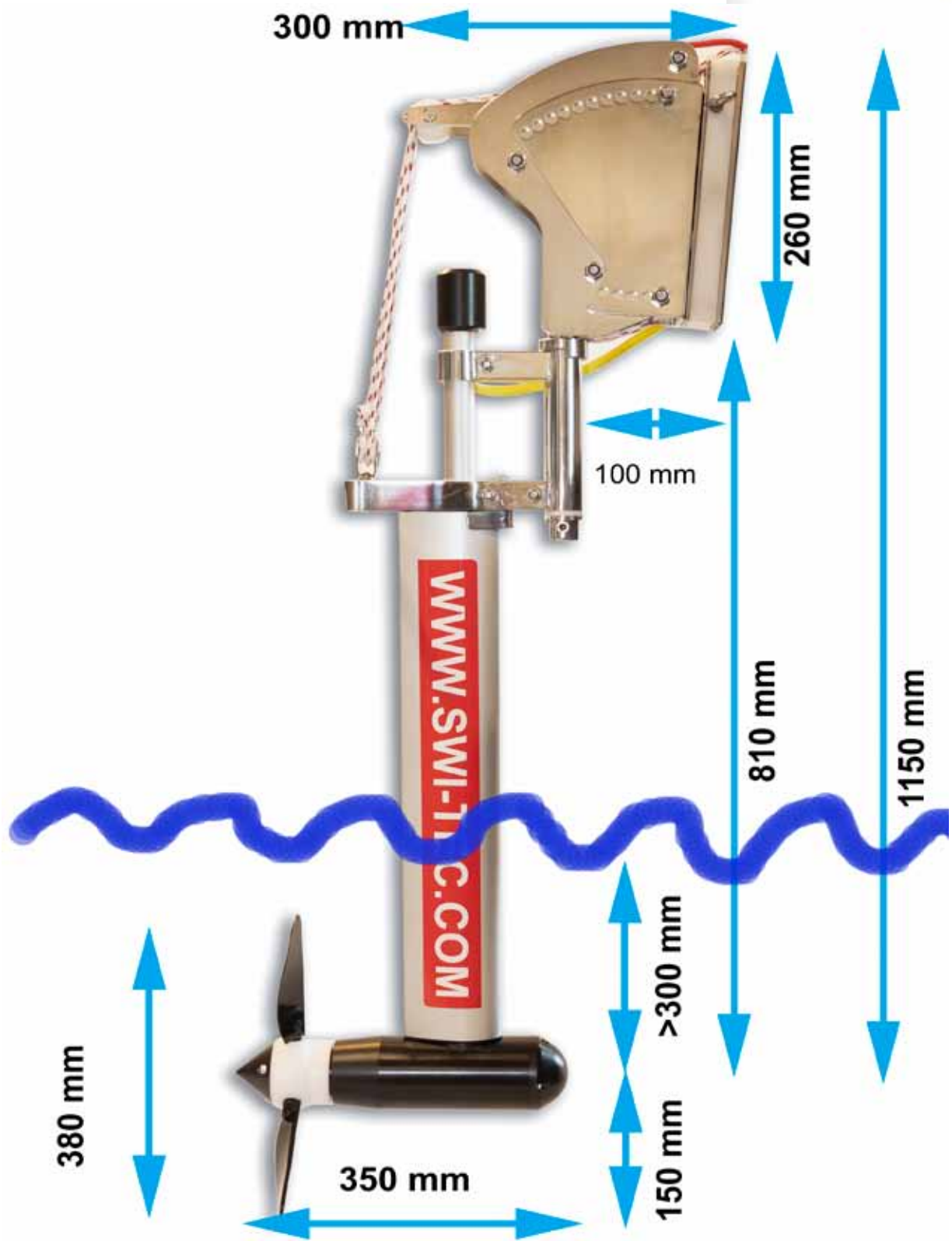

Montage Anleitung Spiegelhalterung - Installation transom mount bracket - Manuel pour l'installation du support de tableau

8
4

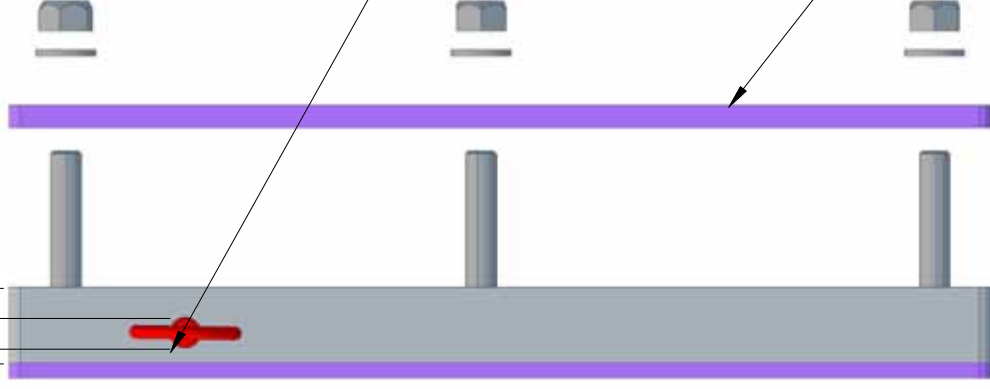

Schmäler Teil des Sicherungsbolzens auf
der Seite vom Hydro Charger
(Vorsicht: Bohrung ist seitlich versetzt)

Small part of the security bolt must be on the
side of the Hydro Charger.
(Attention: the hole is sideward displaced)

Il faut mettre la partie la plus fine de la pièce
de sécurité contre l'Hydro Chargeur.
(Attention: le trou est sur le côté décalé)

Gegenplatte

Counter plate

Contre plaque

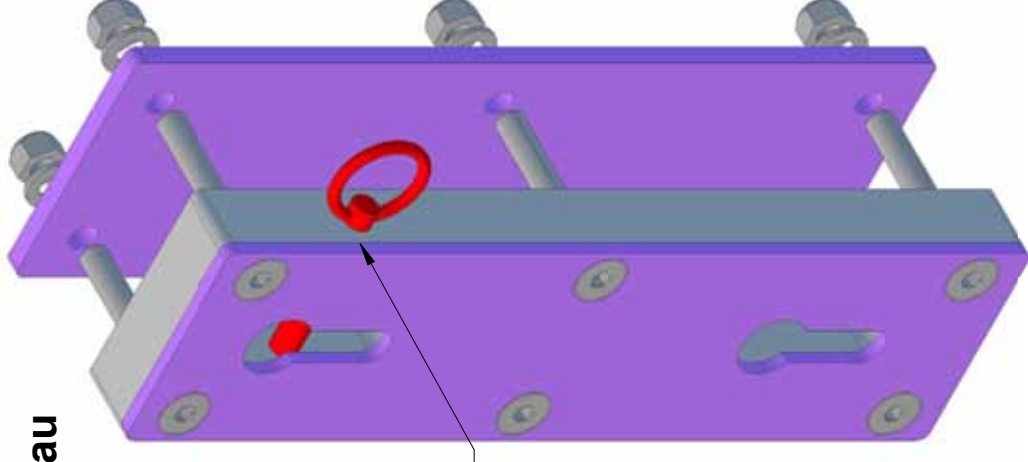

Die Vervielfältigung, Verteilung und Nutzung
dieses Dokuments, sowie die Kommunikation
des Inhalts an Dritte, ohne ausdrückliche
Erlaubnis, ist untersagt. Zuwiderhandlungen
werden nach dem Urheberrechtsgesetz geahndet.
Alle Rechte an den Patenten, Gebrauchsmustern
oder Design vorbehalten.

PROPRIETARY INFORMATION

| | | | | | | | | |
|----------------------------|--|----------------------------|-------|-----------------------|-------------|----------------|----------|--|
| Name | | Gez. | Gepr. | Anzahl: | Geändert am | Material: | Masstab: | |
| Neveta Nautică S.L. (M.B.) | | Neveta Nautică S.L. (M.B.) | | 1 | | Ais 316/Delrin | 1:2 | |
| Datum: | | | | Bestellbezeichnung: | | Gewicht: | | |
| 03.09.2018 | | | | Hydro Charger support | | 2 kg | | |

Propeller Montage - Propeller Installation - Installation hélice

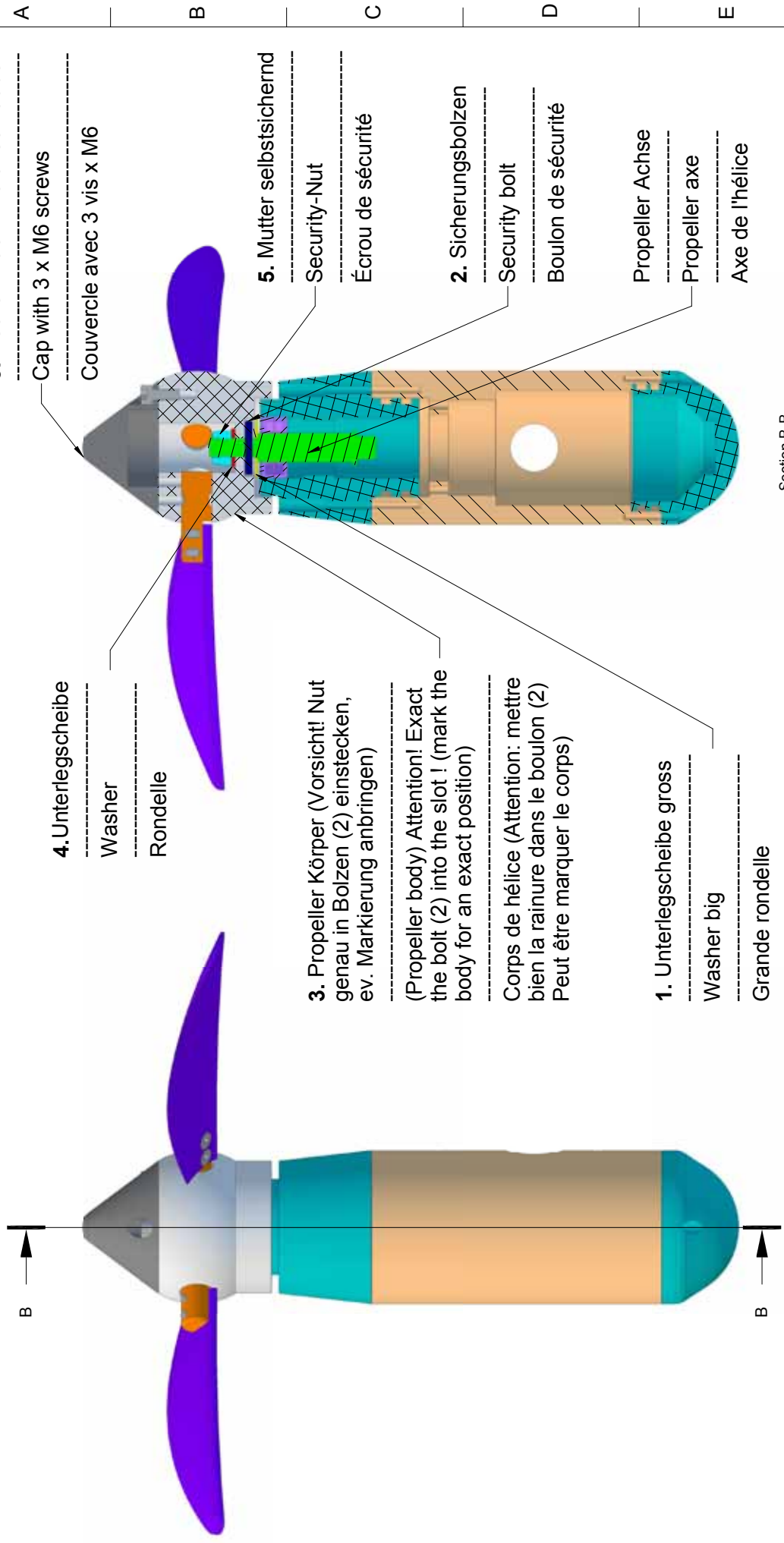

6. Deckel mit 3 x M6 anschrauben
 Cap with 3 x M6 screws
 Couvercle avec 3 vis x M6

4. Unterlegscheibe
 Washer
 Rondelle

3. Propeller Körper (Vorsicht! Nut genau in Bolzen (2) einstecken, ev. Markierung anbringen)
 (Propeller body) Attention! Exact the bolt (2) into the slot ! (mark the body for an exact position)
 Corps de hélice (Attention: mettre bien la rainure dans le boulon (2) Peut être marquer le corps)

1. Unterlegscheibe gross
 Washer big
 Grande rondelle

5. Mutter selbstsichernd
 Security-Nut
 Écrou de sécurité

2. Sicherungsbolzen
 Security bolt
 Boulon de sécurité

Propeller Achse
 Propeller axe
 Axe de l'hélice

Section B-B

Die Vervielfältigung, Verteilung und Nutzung dieses Dokuments, sowie die Kommunikation in Form von Drucken oder elektronischen Erhebungen, ist untersagt. Zuwiderhandlungen werden nach dem Urheberrechtsgesetz geahndet. Alle Rechte an den Patenten, Gebrauchsmustern oder Design vorbehalten.
 INFRANET/NEVETA/NAVIGATION

| | | | | | | |
|------------|--------------------------|-------|---------------------------------------|-------------|---------------|----------|
| Name | Gez. | Gepr. | Anzahl: | Geändert am | Material: | Maßstab: |
| Datum: | Neveta Nautica S.L. (NB) | | 1 | | | 1:2 |
| 02.09.2018 | | | Bestellbezeichnung: SWI-TEC Propeller | | Gewicht:xx kg | |